

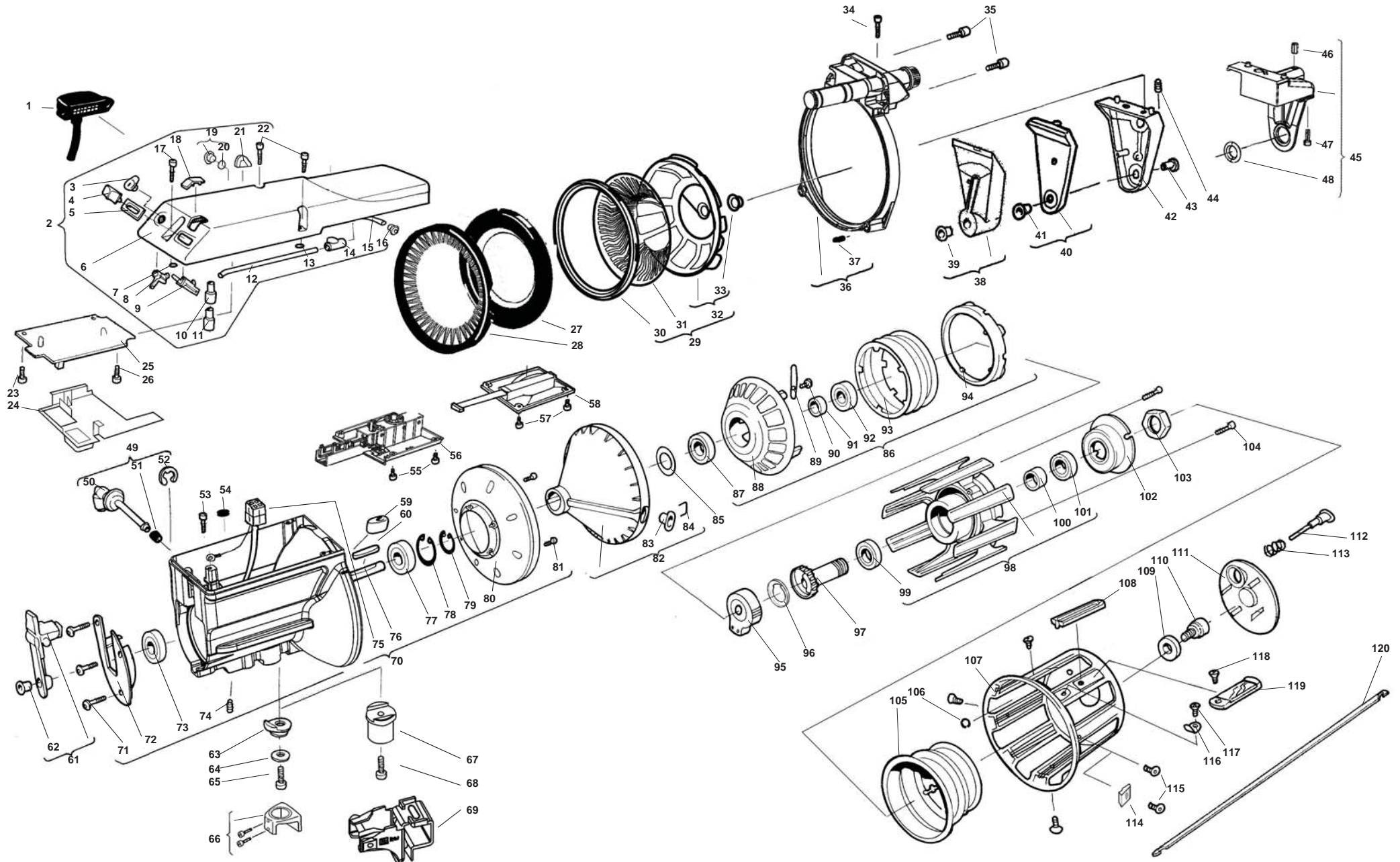



XD X2 - Exploded view



	PAGE 1 (5)	Spare parts list for XD X2 O 7024.XX.XXG XD X2 M 7124.XX.XXG XD X2 700 W 6324.XX.XXF	REF. NO. 24-897G-2001- 07/1551	
---	---------------	---	--------------------------------------	--



Parts specific for optical or mechanical feeders are identified with ☐ in the centre column.
XD X2 Optical sensor = 7024.
XD X2 Mechanical sensor = 7124.
XD X2 700 Watt motor = 6324.
Unmarked positions are common to all feeder models.
If the customer are unsure about the article number should he contact IRO Service department
E-mail service @iro.se

POS	PART NO	DESCRIPTION	7024	7124	6324	REMARKS
1	27.0923.1750	CABLE 1.75 m				
2	24.0325.000L	TOP COVER assy.				Full-threading.
2	24.0325.100L	TOP COVER assy.				Manual and half-threading
3	27.0509	SWITCH, max speed		☐	☐	
4	24.0047	SWITCH, on/off				
5	24.0048	FRAME				
6	24.0007.000L	TOP COVER				
7	900.9355	O-RING				
8	24.0377	MAGNET HOLDER, max speed		☐	☐	
9	24.0376	MAGNET HOLDER on/off				
10	24.0114	CONNECTOR				
11	24.0123	SEAL				
12	25.0652.004	HOSE				
13	900.9355	O-RING				
14	24.0094	T-CONNECTOR				
15	24.0145.002	HOSE				
16	27.0222	CONNECTOR				
17	900.0187	SCREW				
18	24.0069	INDICATOR COVER				
19	27.0724.001	SWITCH s/z				
20	900.9104	O-RING				
21	27.0739	SEALING				
22	900.0187	SCREW				
23	900.0117	SCREW				
24	24.0414	PROTECTION COVER	☐			
24	24.0359	PROTECTION COVER		☐		
24	24.0510	PROTECTION COVER			☐	
25	24.9142.0NNN*	CIRCUIT BOARD Compl.	☐			*Loom model must be specified (Manufacture and type)
25	24.9142.1NNN*	CIRCUIT BOARD Compl.		☐		*Loom model must be specified (Manufacture and type)
25	24.9113.0008	CIRCUIT BOARD Compl.			☐	700 Watt motor
26	900.0117	SCREW				
27	24.0252.001	E-FLEX, SOFT				Strip only = 24.0253.001
27	24.0252.102	E-FLEX, MEDIUM				Strip only = 24.0253.002
27	24.0281.003	E-FLEX, STIFF				Strip only = 24.0253.003
27	24.0281.103	E-FLEX, EXTRA STIFF				Strip only = 24.0253.003
27	24.0378.001	MBS/R SOFT				
27	24.0378.002	MBS/R MEDIUM				
27	24.0378.003	MBS/R STIFF				
27	24.0252.012	L-FLEX SOFT z-rot				
27	24.0252.014	L-FLEX SOFT s-rot				
27	24.0252.112	L-FLEX MEDIUM z-rot				
27	24.0252.114	L-FLEX MEDIUM s-rot				
27	24.0281.016	L-FLEX STIFF z-rot				
27	24.0281.018	L-FLEX STIFF s-rot				
28	24.0261.001	BRUSH SOFT, natural, z-rotation				
28	24.0261.101	BRUSH SOFT, natural, s-rotation				
28	24.0261.201	BRUSH SOFT, natural, straight				
28	54T00774	BRUSH MEDIUM, natural, z-rotation				
28	54T00775	BRUSH MEDIUM, natural, s-rotation				
28	54T00773	BRUSH MEDIUM, natural, straight				

	PAGE 2 (5)	Spare parts list for XD X2 O 7024.XX.XXG XD X2 M 7124.XX.XXG XD X2 700 W 6324.XX.XXF	REF. NO. 24-897G-2001-07/1551	
---	---------------	---	----------------------------------	--



Parts specific for optical or mechanical feeders are identified with α in the centre column.
XD X2 Optical sensor = 7024.
XD X2 Mechanical sensor = 7124.
XD X2 700 Watt motor = 6324.
Unmarked positions are common to all feeder models.
If the customer are unsure about the article number should he contact IRO Service department
E-mail service @iro.se

POS	PART NO	DESCRIPTION	7024	7124	6324	REMARKS
28	24.0261.004	BRUSH MEDIUM, synthetic, z-rotation				
28	24.0261.104	BRUSH MEDIUM, synthetic, s-rotation				
28	24.0261.204	BRUSH MEDIUM, synthetic, straight				
28	24.0261.005	BRUSH STIFF, synthetic, z-rotation				
28	24.0261.105	BRUSH STIFF, synthetic, s-rotation				
28	24.0261.205	BRUSH STIFF, synthetic, straight				
28	54T00783	BRUSH X-STIFF, synthetic, z-rotation				
28	54T00784	BRUSH X-STIFF, synthetic, s-rotation				
28	54T00782	BRUSH X-STIFF, synthetic, straight				
28	24.0261.007	BRUSH STIFF, synthetic, z-rotation				Recommend for fibreglass (diameter=110 mm)
28	24.0261.107	BRUSH STIFF, synthetic, s-rotation				Recommend for fibreglass (diameter=110 mm)
28	24.0261.207	BRUSH STIFF, synthetic, straight				Recommend for fibreglass (diameter=110 mm)
28	24.0261.008	BRUSH SOFT, synthetic, z-rotation				
28	24.0261.108	BRUSH SOFT, synthetic, s-rotation				
28	24.0261.208	BRUSH SOFT, synthetic, straight				
29	54T00706	LAMELLA BRAKE Comp. soft, Z-rotation				Pos. 34 included(Not fitting with 30° nose)
29	54T00707	LAMELLA BRAKE Comp. medium, Z-rotation				Pos. 34 included(Not fitting with 30° nose)
29	54T00708	LAMELLA BRAKE Comp. stiff, Z-rotation				Pos. 34 included(Not fitting with 30° nose)
30	43A00487	LOCKING RING				
31	52T00010	LAMELLA soft, Z-rotation				
31	52T00011	LAMELLA medium, Z-rotation				
31	52T00083	LAMELLA stiff, Z-rotation				
32	52R00080	BASKET WITH EYELET				Pos. 33 included
33	26A00057	EYELET				
34	900.0496	SCREW				
35	900.0496	SCREW				
36	24.0290.001L	BRUSH HOLDR compl.				Full-threading
36	24.0290.002L	BRUSH HOLDER compl.				Manual and Half-threading
37	27.0490.001	LOCATING DOGS				
38	27.0597.001	NOSE EXTENDER compl. 30°				Polished version = 27.0597.002
38	27.0144.100L	NOSE Compl. 30° included pos.32,36,37,38				Polished version = 27.00144.101L
39	900.6163.001	EYELET				
40	27.0465.001	NOSE EXTENDER compl. 42°				Polished version = 27.0465.002
40	27.0144.000L	NOSE Compl. 42° included pos.34,36,37,38				Polished version = 27.00144.001L
41	900.6163.001	EYELET				
42	27.0292.000L	NOSE HOUSING				
43	900.6163.001	EYELET				Polished version = 900.6163.003
44	900.0495	SCREW				
45	24.0392.000L	NOSE 55 DEGREE				24.0392.001L = Polished version
46	900.0495	SCREW				
47	900.0218	SCREW				
48	27.0479.001	EYELET				27.0479.002 = Polished version
49	24.0138	CONNECTOR compl.				
50	24.0027	CONNECTOR				
51	24.0173	GROMMET				
52	900.9364	CIRCLIP				
53	24.0117	SCREW				

	PAGE 3 (5)	Spare parts list for XD X2 O 7024.XX.XXG XD X2 M 7124.XX.XXG XD X2 700 W 6324.XX.XXF	REF. NO. 24-897G-2001-07/1551	
---	---------------	---	----------------------------------	--



Parts specific for optical or mechanical feeders are identified with □ in the centre column.
XD X2 Optical sensor = 7024.
XD X2 Mechanical sensor = 7124.
XD X2 700 Watt motor = 6324.
Unmarked positions are common to all feeder models.
If the customer are unsure about the article number should he contact IRO Service department
E-mail service @iro.se

POS	PART NO	DESCRIPTION	7024	7124	6324	REMARKS
54	24.0371	GROMMET				
55	24.0117	SCREW				
56	24.0328.101	SENSOR Compl.		□		Plasma coated version 24.0328.102
57	24.0117	SCREW				
58	24.0473.001	SENSOR compl.	□			
58	24.0368.002	SENSOR compl.			□	700 Watt motor
59	900.6166	EYELET				Extra polished version = 24.0319
60	900.9314	KEY				
61	24.0026.100	VALVE compl.	□	□		Half-threading (Extra polished version = 24.0026.101)
61	24.0026.200	VALVE compl.	□	□		Manual threading (Extra polished version =24.0026.201)
61	24.0026.110	VALVE compl.			□	700 Watt motor
62	900.6163.001	EYELET	□	□		(Extra polished version = 900.6163.003)
62	24.0491.001	EYELET			□	700 Watt motor
63	24.0433	WASHER				
64	900.2008	WASHER				
65	900.0333	SCREW				
66	24.0462	MOUNT assy.				
67	24.0039	MOUNT SPIGOT			□	
68	900.0346	SCREW			□	
69	24.0070	Mount compl. 700 W motor			□	
70	24.0472.000K	MOTOR COMPL.	□	□		Polished version = 24.0472.001K
70	24.0395.005K	MOTOR COMPL.			□	Polished version = 24.0395.006K
71	900.0187	SCREW				
72	24.0502.000K	BEARING HOLDER	□	□		
72	24.0021.000K	BEARING HOLDER			□	
73	900.4066	BEARING	□	□		
73	900.4069	BEARING			□	
74	900.0518	SCREW			□	
74	900.0529	SCREW	□	□		
75	27.0767.001	STATOR	□	□		
75	24.0495	STATOR			□	
76	24.0469	ROTOR compl.	□	□		Polished version = 24.0469.001
76	24.0365.005	ROTOR compl.			□	Polish version = 24.0365.006
77	900.4067	BEARING			□	
78	900.9099	CIRCLIP				
79	900.9073	CIRCLIP				
80	24.0025	MAGNET RING	□	□		
80	24.0025.001	MAGNET RING			□	
81	900.0478	SCREW				
82	24.0384.101	WINDING DISC compl.	□	□		Extra polished version = 24.0384.102
82	24.0384.201	WINDING DISC compl.			□	Extra polished version = 24.0384.202
83	24.0003	EYELET	□	□		Extra polished version = 24.0003.001
83	24.0493	EYELET			□	Extra polished version = 24.0493.001
84	24.0068	EYELET HOLDER	□	□		
84	24.0490	EYELET HOLDER			□	
85	24.0116	WASHER				
86	24.0287	MAGNET RING compl.	□	□		With stiff bellow for wira machines = 24.0287.001
86	24.0287.002	MAGNET RING compl.			□	
87	900.4065	BEARING				
88	24.0287	MAGNET RING	□	□		
88	24.0287.002	MAGNET RING			□	

	PAGE 4 (5)	Spare parts list for XD X2 O 7024.XX.XXG XD X2 M 7124.XX.XXG XD X2 700 W 6324.XX.XXF	REF. NO. 24-897G-2001- 07/1551	
---	---------------	---	--------------------------------------	--

Parts specific for optical or mechanical feeders are identified with ☐ in the centre column.
XD X2 Optical sensor = 7024.
XD X2 Mechanical sensor = 7124.
XD X2 700 Watt motor = 6324.
Unmarked positions are common to all feeder models.
If the customer are unsure about the article number should he contact IRO Service department
E-mail service @iro.se

POS	PART NO	DESCRIPTION	7024	7124	6324	REMARKS
89	24.0124	EARTH STRIP				
90	900.0478	SCREW				
91	24.0058	SPACER				
92	900.4065	BEARING				
93	24.0033	BELLOW	☐	☐		Stiff bellow for wira machines = 24.0033.001
93	24.0439	BELLOW			☐	
94	24.0072	BELLOW RING	☐	☐		
95	24.0456	COUNTERWEIGHT				
96	24.0457	WASHER				
97	24.0437.002	INCLINED HUB				XL sep = 24.0437.003, XS sep = 24.0437.004
98	24.0141	TUMBLE CYLINDER assy.				Plasma coated version = 24.0141.001
98	24.0141.002	TUMBLE CYLINDER assy. ONE WAY bearing				Plasma coated version ONEWAY bearing 24.0141.003
98	24.0141.004	TUMBLE CYLINDER assy. XL-sep				Plasma coated version XL-sep 24.0141.005
98	24.0141.006	TUMBLE CYLINDER assy. XL-sep ONEWAY BEARING				Plasma coated version ONEWAY bearing XL-sep 24.0141.007
98	24.0141.008	TUMBLE CYLINDER assy. XL-sep sand blasted				
99	900.4064	BEARING				Sand blasted XL -sep = 900.4068
100	24.0059	SPACER				
101	900.4064	BEARING				One-way bearing = 900.4031
102	24.0270	S/Z RING				
103	31.0350	NUT				
104	900.0585	SCREW				
105	24.0242	BELLOW				
106	900.9058	CIRCLIP				
107	24.0237	SPOOL BODY				
107	24.0237.001	SPOOL BODY Extra polished				
107	24.0237.002	SPOOL BODY Ribbed front				
107	24.0237.008	SPOOL BODY Relaxing ramp + concave				
107	24.0320	SPOOL BODY Plasma coated				
107	24.0320.001	SPOOL BODY Plasma coated + XL-separation				
107	24.0320.002	SPOOL BODY Plasma coated + XL-separation +relaxing ramp.				
107	24.0438.005	SPOOL BODY Relaxing ramp +ribbed front				
107	24.0438.006	SPOOL BODY XL-separation				
107	24.0438.010	SPOOL BODY Relaxing ramp +ribbed front +concave +blasting				
108	24.0245	INSERT		☐		
109	24.0137	SPRING WASHER				
110	24.0134	SCREW				
111	27.0160	COVER				
112	24.0269	S/Z-BUTTON				
113	27.0163	SPRING				
114	24.0521	RELAXING RAMP				
115	900.0120	SCREW				
116	24.0244	YARN BREAK MIRROR	☐		☐	
117	900.0327.001	SCREW	☐		☐	

	PAGE 5 (5)	Spare parts list for XD X2 O 7024.XX.XXG XD X2 M 7124.XX.XXG XD X2 700 W 6324.XX.XXF	REF. NO. 24-897G-2001- 07/1551	
---	---------------	---	--------------------------------------	--

Parts specific for optical or mechanical feeders are identified with □ in the centre column.
XD X2 Optical sensor = 7024.
XD X2 Mechanical sensor = 7124.
XD X2 700 Watt motor = 6324.
Unmarked positions are common to all feeder models.
If the customer are unsure about the article number should he contact IRO Service department
E-mail service @iro.se

POS	PART NO	DESCRIPTION	7024	7124	6324	REMARKS
118	900.0426	SCREW	□		□	
119	24.0422	REFLECTOR compl.	□			
119	24.0422.002	REFLECTOR compl.			□	
120	24.0174	THREADING NEEDLE				
200	24.0641	CONE COMPLETE	□			
200	24.0641.001	CONE COMPLETE		□		
201	900.0075	SCREW				
202	24.0637	CONE				
203	27.0479.001	EYELET				
204	24.0640	SLIDE COMPLETE				