

Weft feeders & Accessories

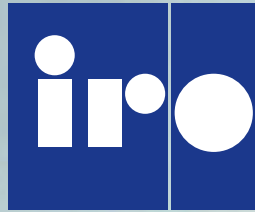

ROJ

Our way to the perfect fabric.

We are the leader in developing Weft Feeders for the textile industry.

With over 60 years experience in weft insertion solutions.

Our weft insertion systems, designed to elevate your manufacturing processes to unprecedented levels of efficiency and accuracy.

Always designed with high-quality materials and precision engineering to provide you with a seamless and exceptional performance.

Our Weaving Division, comprising Vandewiele Sweden AB, ROJ Srl Italy and Vandewiele (China) Textile Machinery Co. Ltd., develops, produces and markets our branded equipment for the world-wide textile industry.

We focus on providing customer centric solutions by utilising our comprehensive network of agents and distributors to support our customers world-wide.

Welcome to our digital tool **iroonline.com**

Use our e-commerce platform for ordering
the market's best range of textile accessories.

It will facilitate your everyday
life for better business.



The well-proven design combined with new possibilities for modular build-up of the weft feeder. This is a message to all customers that uses weft feeders, to feel confident that we are assisting the market for the future that lays ahead of us all.

The X4 generation connects to our reliable and existing power supply/interface boxes that are present on the market today and installed on rapier/projectile weaving machines, which makes the shift to the X4 generation even easier for our customers.

Chrono X4



Luna X4

- Spool body size 110 mm diameter
- Equal technical performance as Chrono X4
- Compact design, especially suitable for multi-colour installations.
- Can be mixed with Chrono X4 or previous models of the X2/X3 generation weft feeders since the same power supply is being used.

STANDARD



The TED function is an integrated display where you can set desired tension value for the fabric production. Easily viewed on the display, and includes also alarms for example weft yarn break.

All settings made with the yellow knob in front of the weft feeder.

Main standard features

- Fully automatic "intelligent" speed control
- CAN communication system
- Powerful permanent magnet motor
- Extremely low energy consumption
- Multiple yarn store sensors
- Built-in yarn break sensors

OPTIONAL



ATC-W

The integrated display is also compatible with our **ATC Active Tension Control** which will maintain tension through the full weaving cycle. Well-proven design combined with new possibilities for modular build-up of the weft feeder.

OPTIONAL



S-Flex
Compensating tensioner and balloon control

Developed with a design focused on the combination of "balloon control" and "braking" functionality. That covers a range of typical yarns and applications.

An optimized braking cone ensures a solution with excellent performance and further improved resistance to wear.

OPTIONAL



RTC
Rapid Tension Control

A fast reacting, programmable weft tensioner system. It allows adjusting "within-the-pick" to different tension levels, achieving the optimal tension required for the complete weft insertion cycle.

Technical specifications

	LUNA X4	CHRONO X4
Maximum speed	2000 m/min	2000 m/min
Yarn count range	120 - 1.5 Nm and 22 - 4000 dTex	120 - 0.8 Nm and 20 - 5000 dTex
Winding direction	"S" and "Z"	"S" and "Z"
Yarn separation	2.7 mm	4 mm
Sensor systems	Optical or mechanical	Optical or mechanical
Spoolbody diameter	110 mm	135 mm
Dimensions	190 mm height 345 mm length 150 mm width	220 mm height 420 mm length 190 mm width
Weight	6.2 kg	8.6 kg

Adapted to the well-proven design of the X4 generation, the XD X4 has been created to meet requirements for the countless variations in yarn fibers that continue to arise. With decades of experience in yarn feeding, resulted in continuation of the XD series of weft feeders, this to prepare for upcoming challenges that lays ahead of our customers.

XD X4

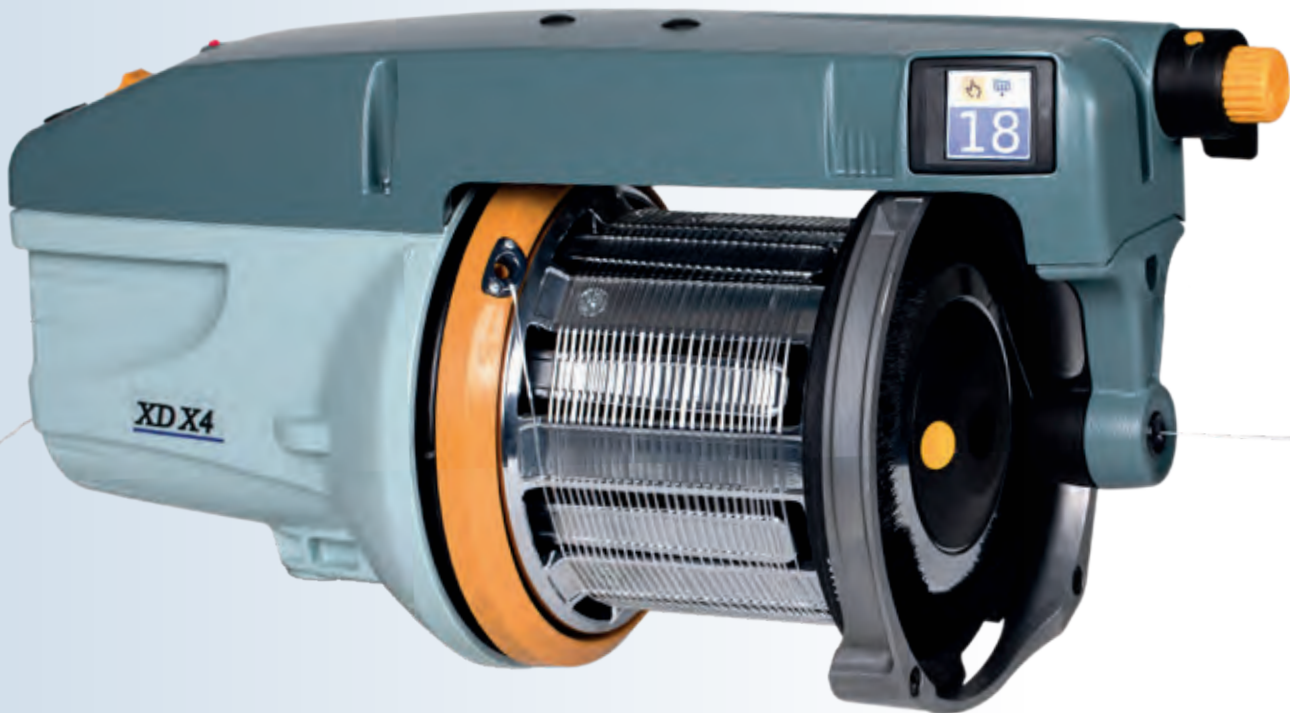

STANDARD

TED

The **TED function** is an integrated display where you can set desired tension value for the fabric production. Easily viewed on the display, and includes also alarms for example weft yarn break.

All settings made with the yellow knob in front of the weft feeder.

OPTIONAL

ATC-W

The integrated display is also compatible with our **ATC Active Tension Control** which will maintain tension through the full weaving cycle. Well-proven design combined with new possibilities for modular build-up of the weft feeder.

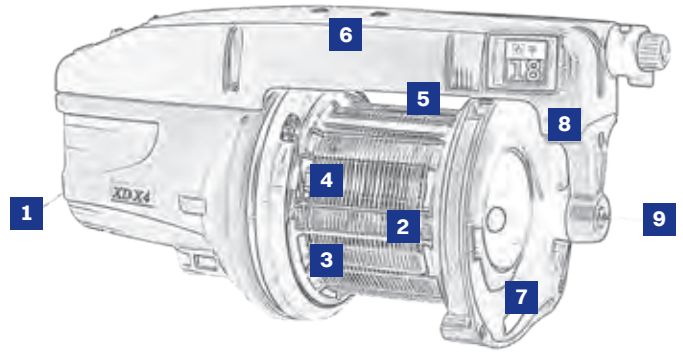

Technical textiles

	1 Input	2 Spool body	3 Tumble cylinder	4 Separation	5 Sensor	6 Others	7 Brake/balloon control	8 Output angle	9 Output accessories
Mono filament diameter 0.1 - 0.7 mm	Rotating ceramic disc + large balloon breaker	Plasma coated, concave	Plasma coated	Standard	Optical	One-way bearing	Brush ring stiff synthetic "Z"	42°	Double rotating ceramic disc
Aluminium wire 0.05 - 0.15 mm	Compensator	Chromed, concave	Chromed	Standard	Optical	Sealed circuit board area	Brush ring medium natural "Z"	42°	Double rotating ceramic disc
Aluminium wire 0.15 - 0.4 mm	Rotating ceramic disc	Chromed, concave	Chromed	Standard	Optical	Sealed circuit board area	Brush ring stiff synthetic "Z"	42°	Double rotating ceramic disc
Aramid fibre 3 mm flat	Compensator	Chromed, pepped surface, concave	Chromed	XL	Optical	Stiff bellow	Brush ring stiff synthetic "Z"	55°	Uni-Brake
Roving texturized < 500 tex	None	Chromed, relaxation ramp, concave	Chromed	XL	Optical		Brush ring medium natural "Z"	55°	Double rotating ceramic disc
Glass fibre parallel filament	None	Chromed, polished surface, concave	Chromed	Standard	Optical	Polished shaft, polished eyelets	Brush ring stiff synthetic, long bristles "Z"	30°	Double rotating ceramic disc
Glass fibre twisted filament	Compensator	Chromed, concave	Chromed	Standard	Optical	Polished eyelets	Brush ring stiff synthetic, long bristles "Z"	30°	Double rotating ceramic disc
Carbon fibre (not flat)	Compensator	Chromed, relaxation ramp, concave	Chromed	Standard	Optical	Sealed circuit board area	Brush ring stiff synthetic "Z"	30°	Uni-Brake

OPTIONAL



RTC Rapid Tension Control

A fast reacting, programmable weft tensioner system. It allows adjusting "within-the-pick" to different tension levels, achieving the optimal tension required for the complete weft insertion cycle.

Technical specifications

XD X4

Maximum speed	2000 m/min
Yarn count range	120 - 0.5 Nm and 22 - 10000 dTex
Winding direction	"S" and "Z"
Yarn separation	6 mm
Sensor systems	Optical or mechanical
Spoolbody diameter	135 mm
Dimensions	220 mm height 420 mm length 190 mm width
Weight	8.6 kg

The weft feeder of choice for extremely demanding applications such as flat polypropylene tape, rowing material and other very dusty material produced on projectile or rapier weaving machines, that today are ending up as production of technical textile, ground supporting material and bags.

HD X3



Balloon Control Design

Quick release and adjustable position for balloon control funnel.

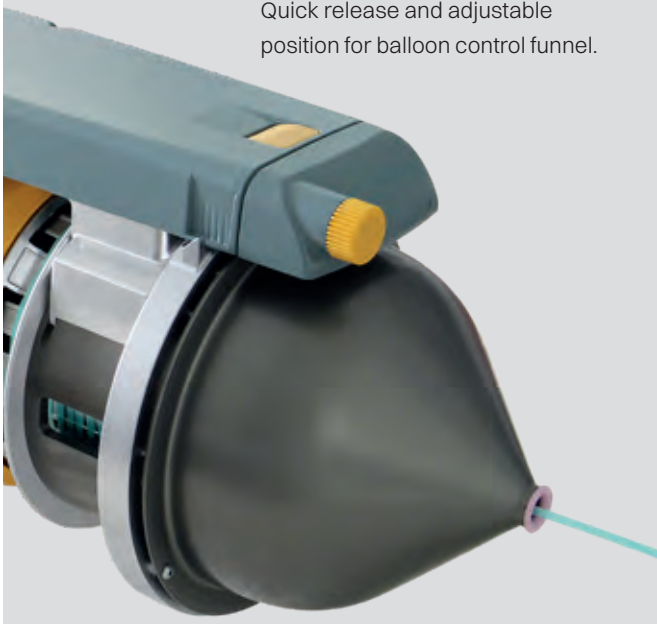

Yarn Input Design

Input eyelet fixed with screws and a more robust construction.

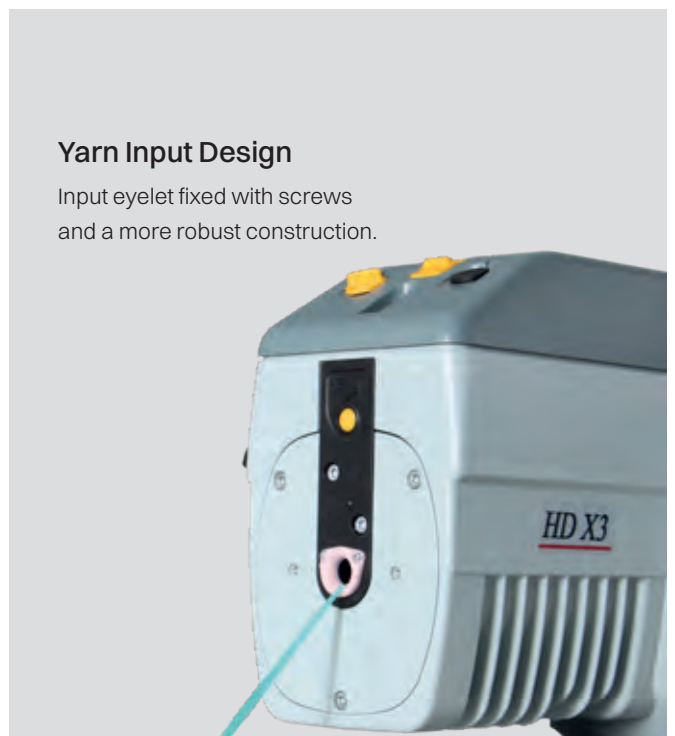

This type of weft feeder is designed for demanding applications where the weft yarn is thick monofilament, thick filament yarns and jute yarns where the take-off speed is of importance.

The weft feeder is widely used on rapier machines for flooring production and wide paper wire machines where the demands are extreme.

XD X3 plus

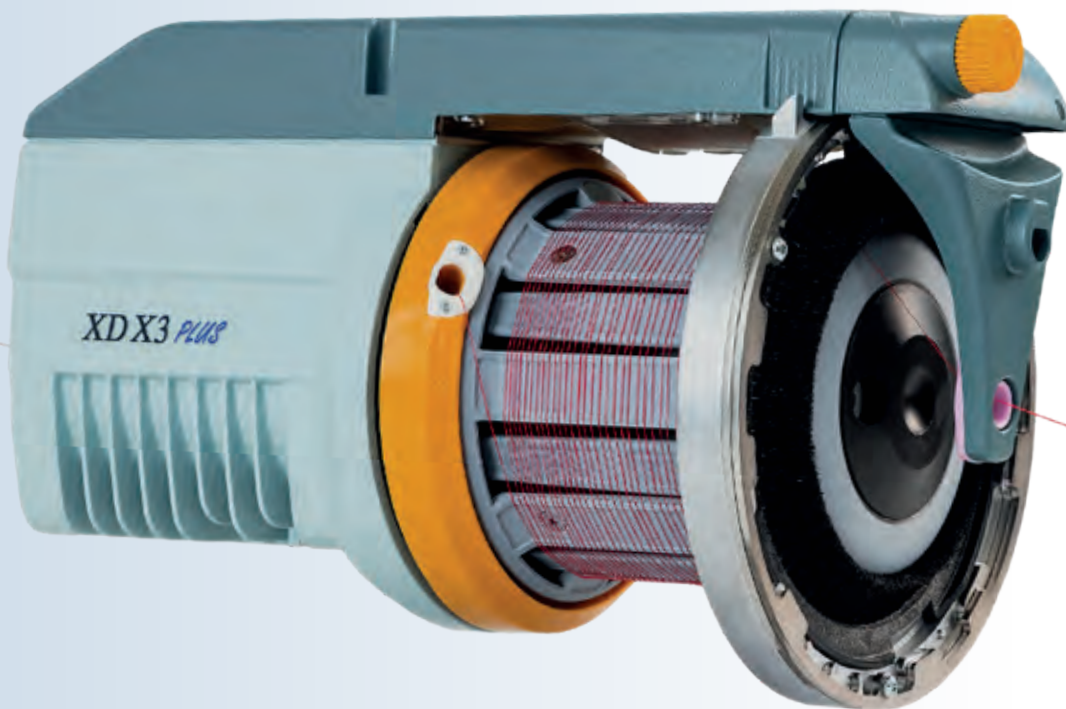

Customised solutions for unique applications – the choice is yours.

- Mono filament 0,8- 2,5 mm diameter
- Jute
- Aramid fibre
- Carbon fibre
- Polyester
- Nylon
- Polypropylene
- Glass fibre

Voltage power supply boxes of reliable transformer technique available in 4-colour or 8-colour executions.

Technical specifications

	HD X3	XD X3 PLUS
Maximum speed	1800 m/min	1800 m/min
Yarn count range	120 - 0,8 Nm and 20 - 5000 dTex	120 - 0,8 Nm and 20 - 5000 dTex
Winding direction	"S" and "Z"	"S" and "Z"
Yarn separation	5 mm	5 mm
Yarn passage	9 mm	9 mm
Sensor systems	Mechanical	Optical
Spoolbody diameter	135 mm	135 mm
Dimensions	190 mm height 345 mm length 150 mm width	190 mm height 345 mm length 150 mm width
Weight	14 kg	14 kg

The basic weft feeders are designed to handle up to medium range speeds of modern weaving machines, but also as replacement on older weaving machines still in operation.

All our weft feeders are equipped with permanent magnet motors for low energy consumption combined with high performance.

Stella G2 / Laser G2

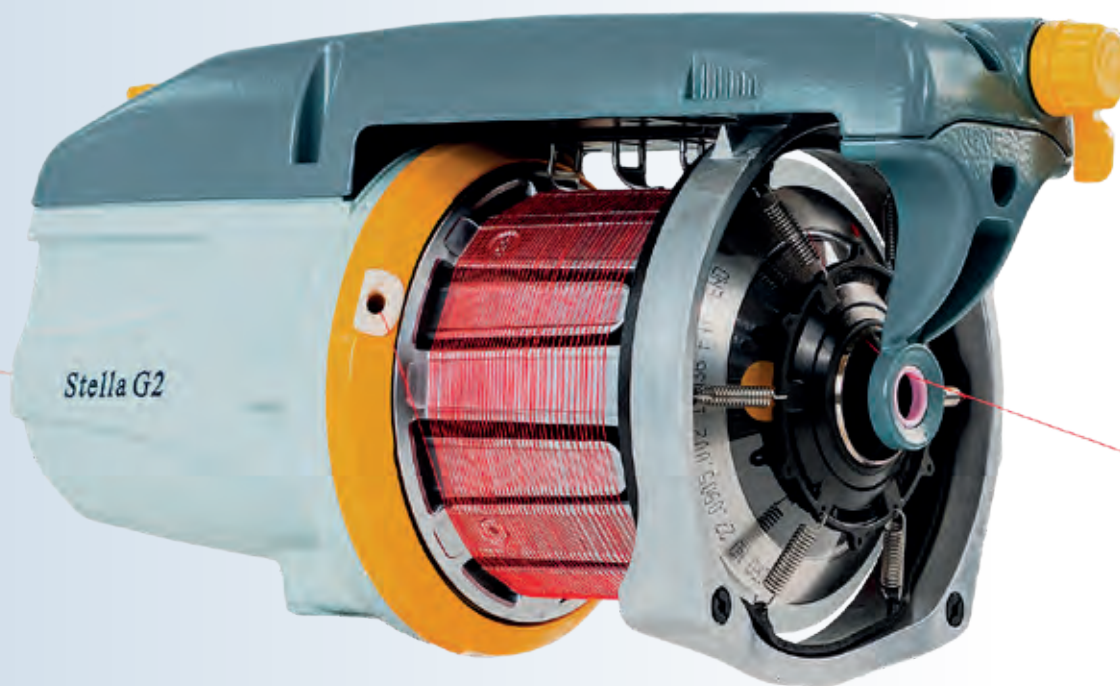

OPTIONAL



S-flex

Compensating tensioner and balloon control. An optimized braking cone ensures a solution with excellent performance and further improved resistance to wear.

For Stella G2/Laser G2.

OPTIONAL



Uni-brake

The Uni-brake surpasses all existing models of traditional leaf tensioners. High performance, extended longevity and user-friendliness.

For all basic weft feeders.

Main differences are that Star G2 can only be fitted with brush ring as balloon control device while Laser/Stella G2 are designed to also handle a S-flex combined balloon control and integrated tension device.

Star G2

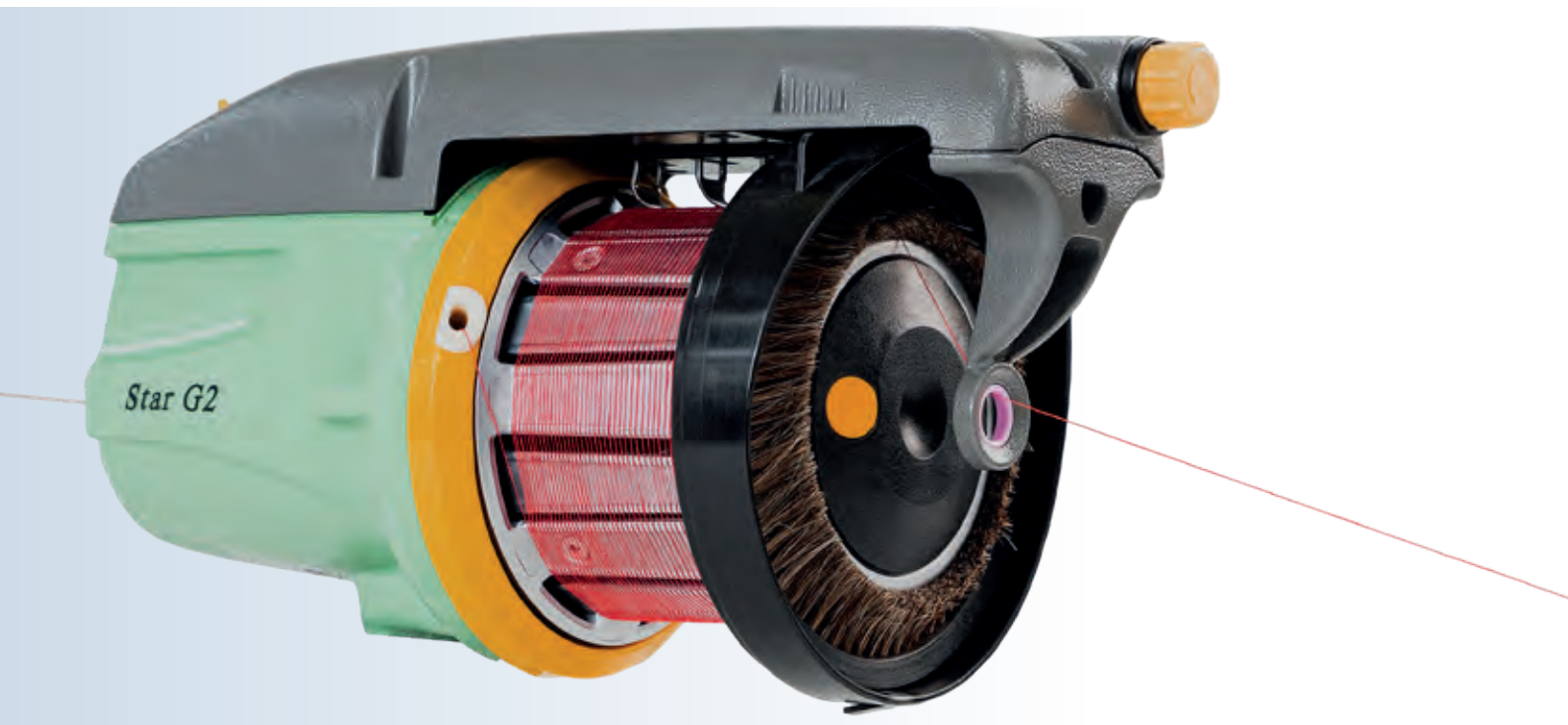

CAT Coaxial Tension device

All basic models can be equipped with CAT as optional plus the standard assortment of in/output brakes available.

For all basic weft feeders.

Technical specifications

	STELLA G2 / LASER G2	STAR G2
Maximum speed	1500 m/min	1200 m/min
Yarn count range	120 - 1.5 Nm and 6 - 4000 dTex	120 - 2 Nm and 20 - 3500 dTex
Winding direction	"S" and "Z"	"S" and "Z"
Yarn separation	2.7 mm	2.2 mm
Sensor systems	Mechanical	Mechanical
Spoolbody diameter	110 mm	110 mm
Dimensions	220 mm height 305 mm length 150 mm width	190 mm height 305 mm length 150 mm width
Weight	4.9 kg	4.7 kg

All basic weft feeders exist in models that cover today's range of power supply boxes, this make replacement easy for the customer.

The Super-Elf S3 continues the evolution of ROJ weft feeders for air- and water-jet weaving machines. With the introduction of the latest optical sensor technology based on the principle of “signal reflection”, provides an extremely accurate sensing of the yarn, even in the most difficult weaving working environments. The Super-Elf S3 can be installed on any type of air or water-jet loom equipped with CAN communication, except for Picanol Air-jet weaving machines.

Super Elf S3



All Super-Elf models fit on existing voltage supply boxes ensuring that future proof availability for the customer is secured.

Technical specifications

	SUPER ELF S3	SUPER ELF G2
Maximum speed	2450 m/min	2000 m/min (2400 m/min with pattern in advance)
Yarn count range	6 Nm - 7 den	6 - 20 dTex
Winding direction	"S" and "Z"	"S" and "Z"
Yarn separation	2.2 mm	2.2 mm
Sensor systems	Optical	Optical
Spoolbody diameter	110 mm	110 mm
Dimensions	170 mm height 325 mm length 130 mm width	170 mm height 325 mm length 130 mm width
Weight	9.5 kg	9.5 kg

Super Elf G2 - an extremely successful product, it combines the latest high technology with the proven performance and capability of the well-known ROJ Super Elf weft feeders for air and water-jet looms. The Super Elf G2 is suitable for new looms as well as a retrofit option for older machines.

Super Elf G2



RELIABLE DESIGN



OPTIONAL



The Super-Elf HD + is designed specifically for weaving PP/PE tape and other coarse yarns used for technical fabrics produced on air and water-jet weaving machines.

As future proof for the customer, all today's existing Super-Elf models are possible to connect on to existing voltage supply boxes, making upgrades easy to conduct.

Super Elf HD+



Technical specifications

SUPER ELF HD+

Maximum speed	2400 m/min
Yarn count range	6 - 20 dTex
Winding direction	"S" ("Z" optional)
Yarn separation	3.5 mm
Sensor systems	Optical
Spoolbody diameter	110 mm
Dimensions	170 mm height 325 mm length 130 mm width
Weight	9.5 kg



The perfect fabric is the result of a combination of elements in the weaving process. With a key element being the correct set-up of the weft feeders used on a rapier weaving machine. We would like to share our expertise with recommendations of many different woven applications to help create perfect fabric.



Wool

Quality and status are traditions we proudly share with wool weavers.

Yarn type: **Wool - Worsted wool**

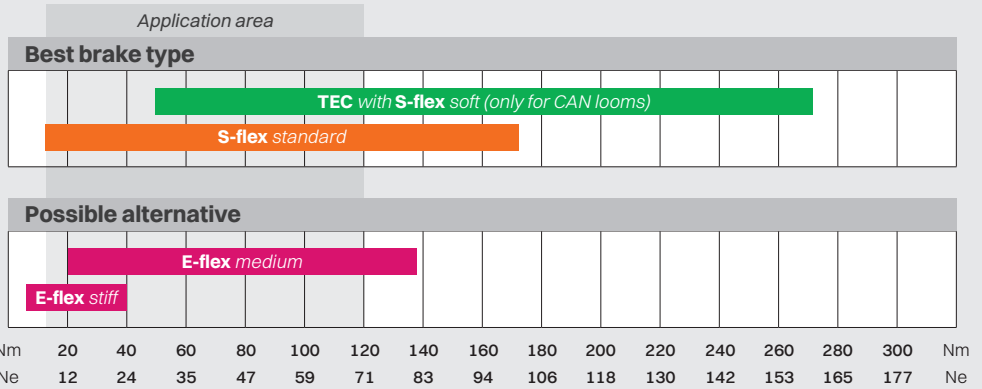

Shirting

A fresh, clean shirt everyday, chosen to show our style, attitude and individuality. The same criteria by which we challenge ourselves in the innovation of our products.

Yarn type: **Cotton - Spun fibre yarns**

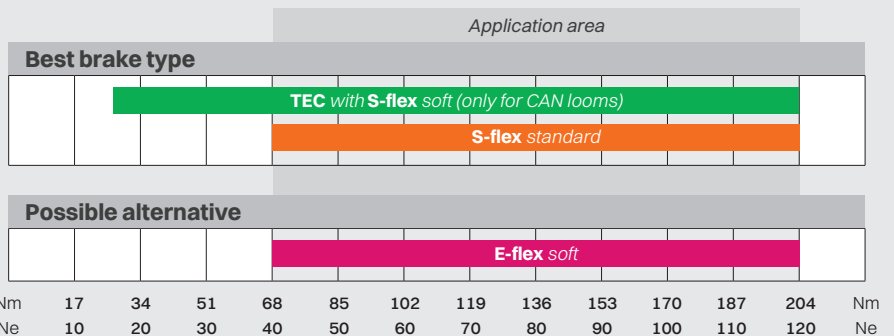



Furnishing and upholstery

Unique fabrics produced for home furnishings using flexible weaving technology.

Yarn type: **Chenille**

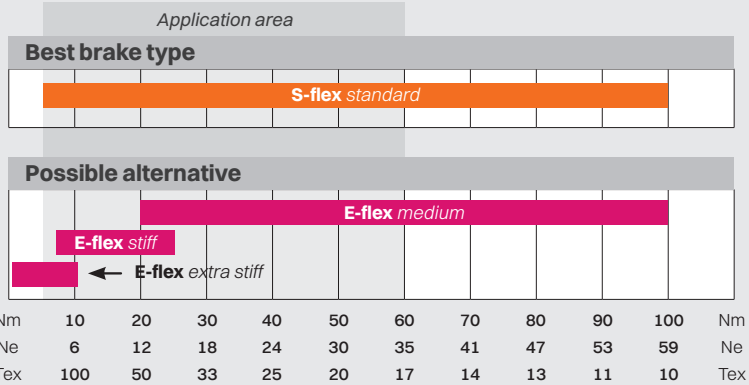

Yarn type: **Fantasy yarns (slub and nub)**

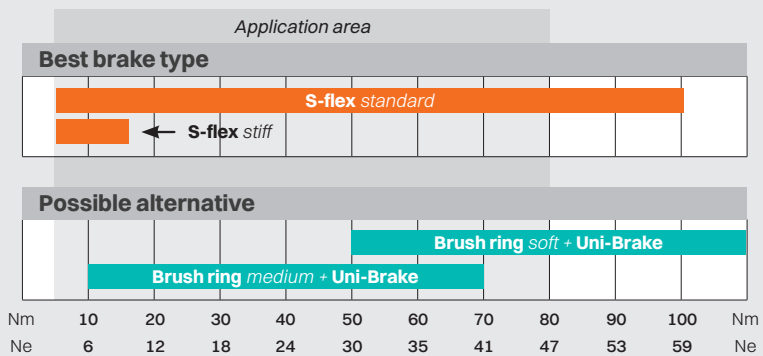

Denim

Like denim and the denim weavers, our feeder systems are designed by building on the traditional with a view to the modern. To produce durable value for our costumers.

Yarn type: **Cotton - mixed and elastic**

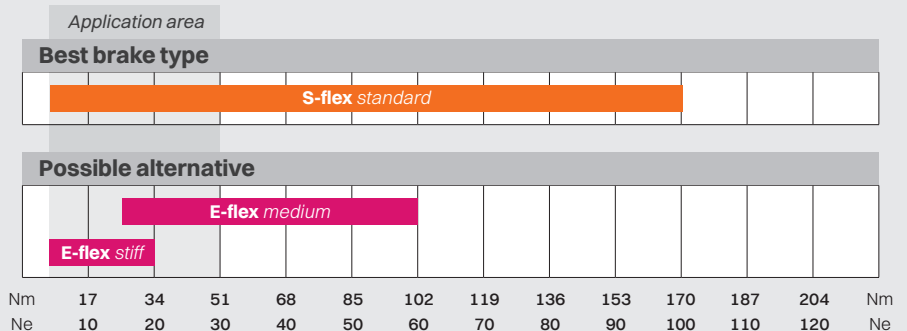



Silk, filament and fancy fabrics

Details, creativity and flare - characteristics we share with the designers of fancy fabrics and accessories.

Yarn type: **Silk - High twisted yarns**

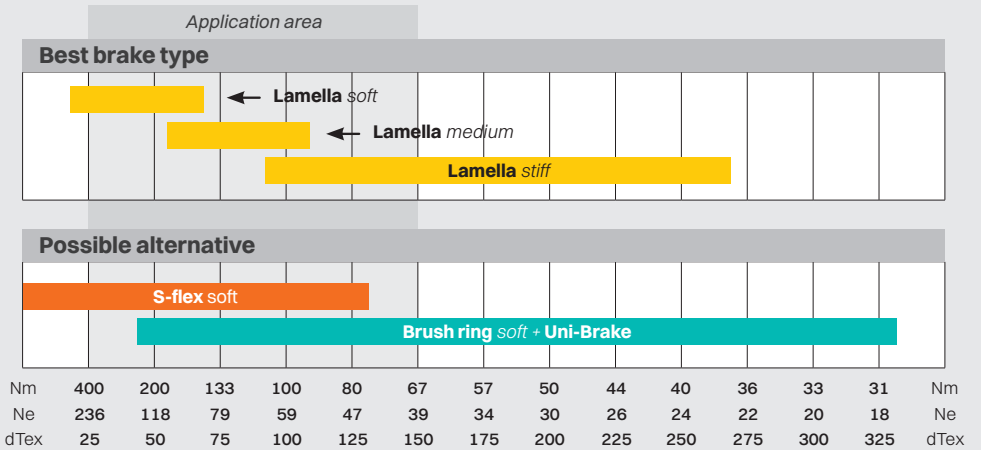

Yarn type: **Filament yarns**

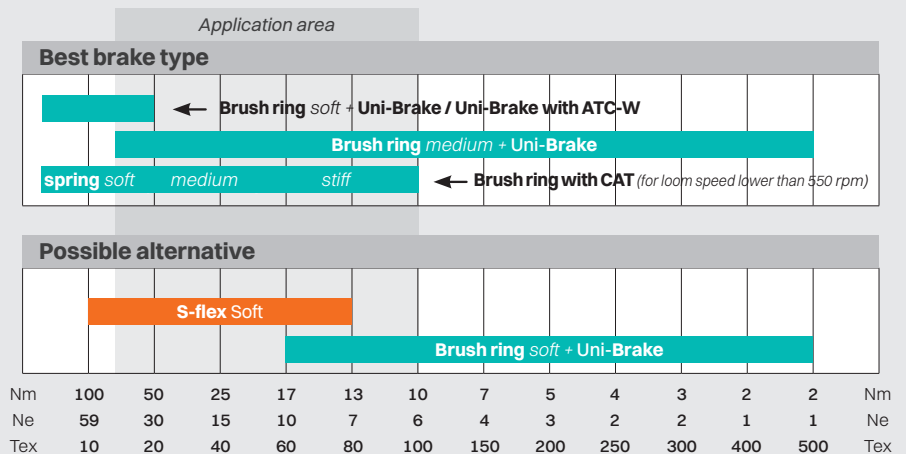

Knot sensor



ATC-W Active Tension Control



ATC Uni-brake



Curtains

Imagination is a key element in the creation of fancy fabrics.

Yarn type: **Chenille**

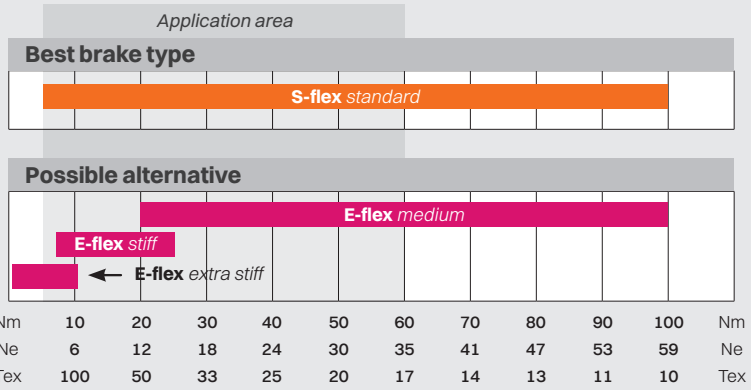

Yarn type: **Fantasy yarns (slub and nub)**

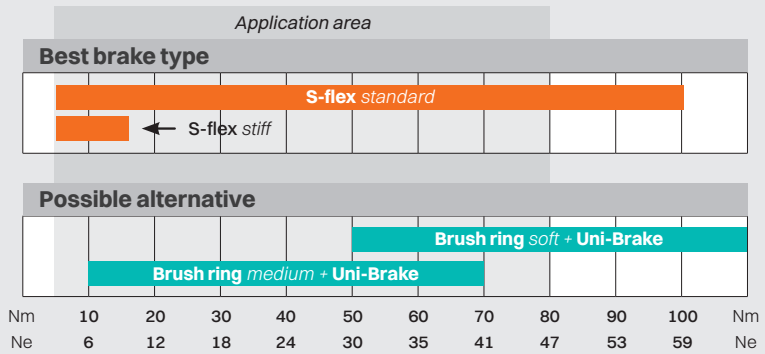

Yarn type: **Silk - High twisted yarns**

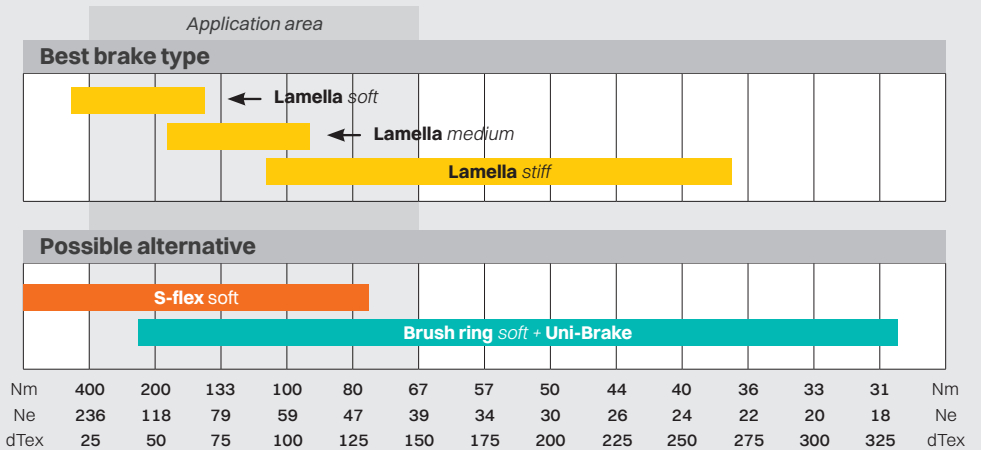



Tablecloths and household linen

Natural fibres woven with simplicity to furnish the most elegant tables is an art in itself.

Yarn type: **Stiff fibres - Linen, flax, jute**

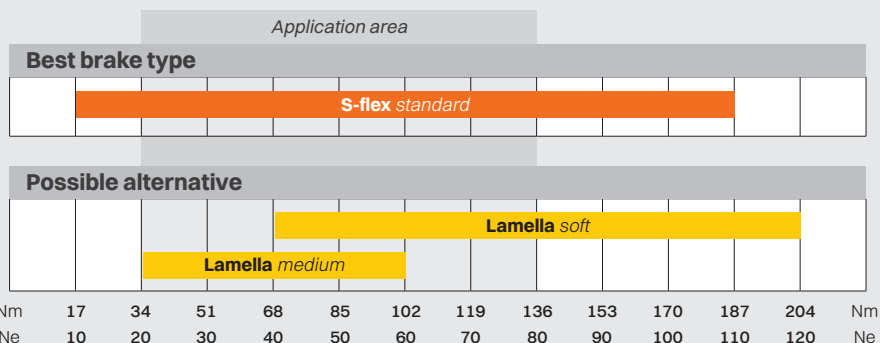

Bed sheeting and towels

Woven to ensure personal comfort.

Yarn type: **Cotton - Spun fibre yarns**

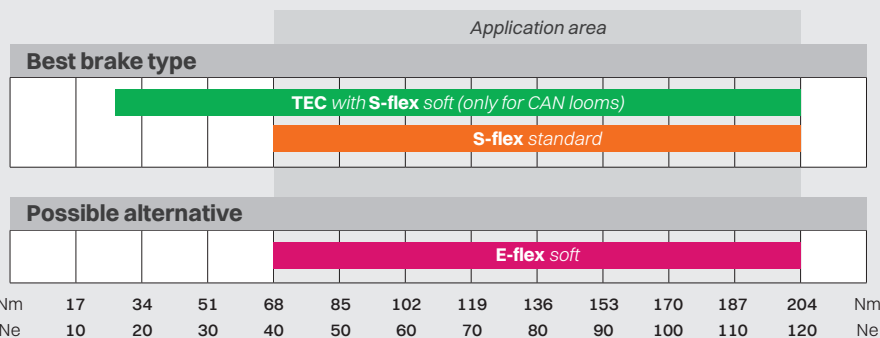



Automotive and technical fabrics

Numerous variations in yarn types continues to present new challenges, but our wealth of experience ensures we are a perfect partner in the weaving process.

Yarn type: Spun fibre yarns

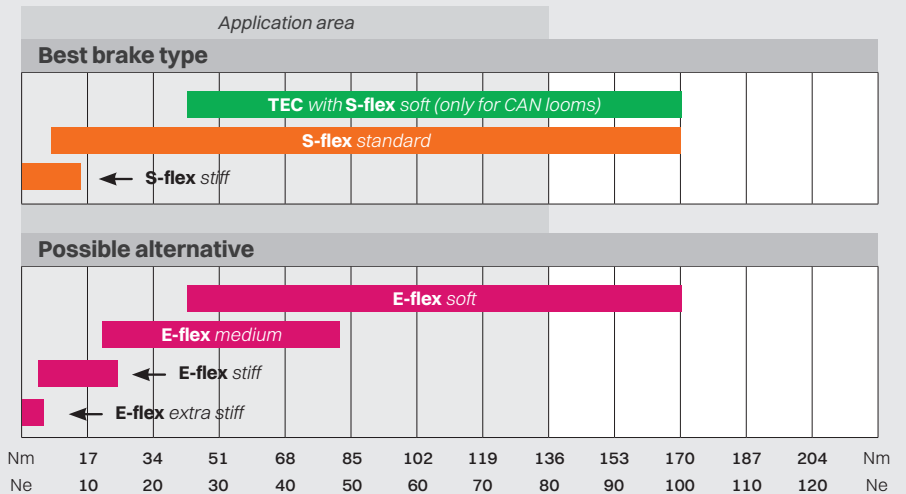

Yarn type: Filament yarns

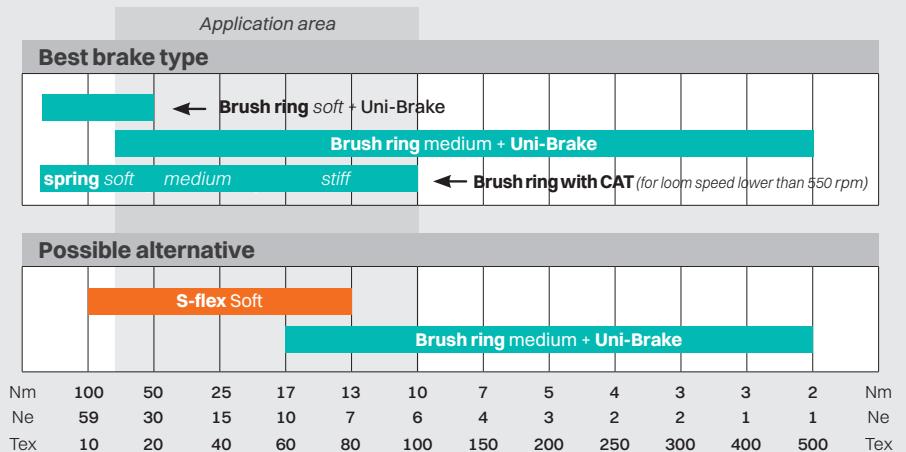

Our complete range of accessories

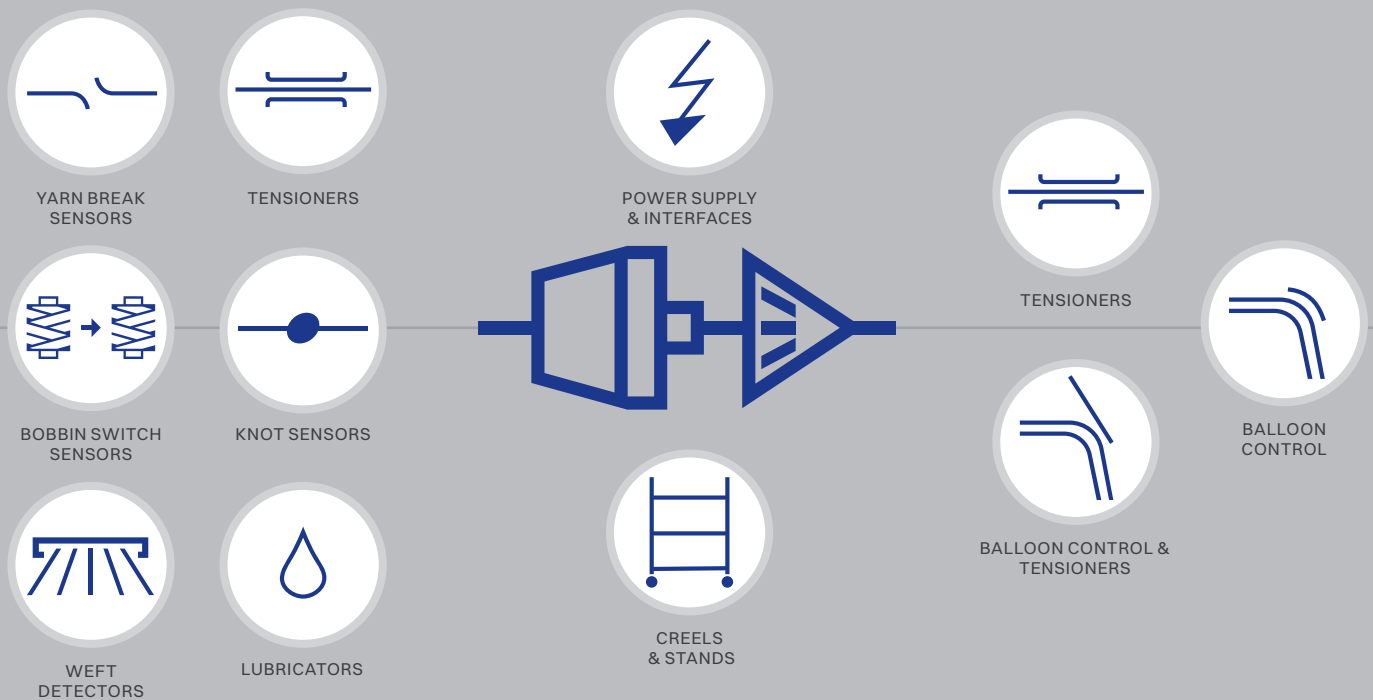

Our comprehensive range of accessories are tools to further optimise the feeders performance and bring your weft insertion to the highest level. To ensure the highest quality of your woven product.

Our extensive range of accessories covers everything needed to improve tension and balloon control, including sensors for the detection of knots, yarn breaks and bobbin switch-over.

Also a range of accessories for lubricating the yarn.

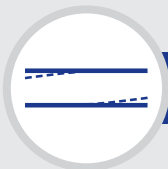

Low Twist X3

The Low Twist X3 unit is essentially an unrolling device, utilising an optical sensor system to ensure that the rotation of the package is synchronised with the weft insertion speed of the loom.

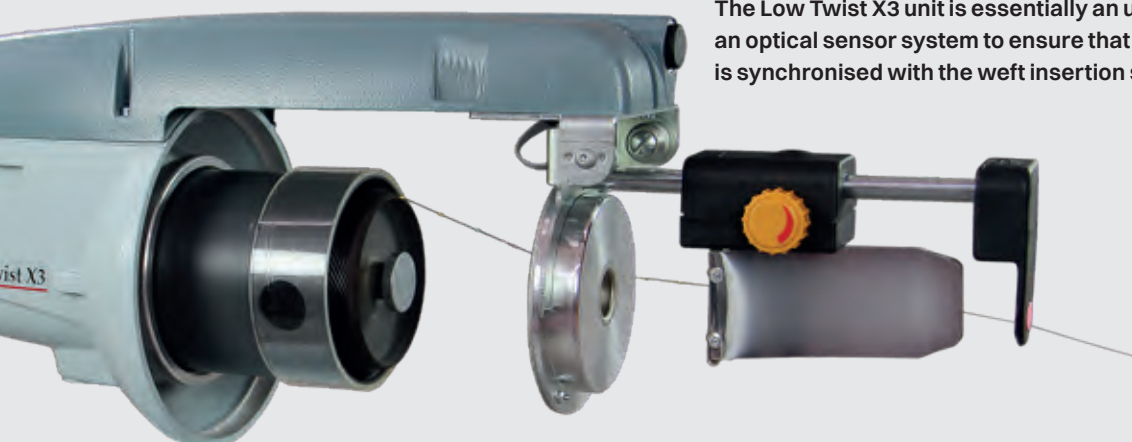

This application is specifically designed to improve the weaving of metallized polyester film e.g. Lurex, since it can reduce the twist from ribbon yarn when being drawn from the package.

The Low Twist X3 unit must be installed behind a weft feeder. The new model Low Twist X3 unit connects to the same Voltage supply box of the X2 / X3 generation of weft feeders.

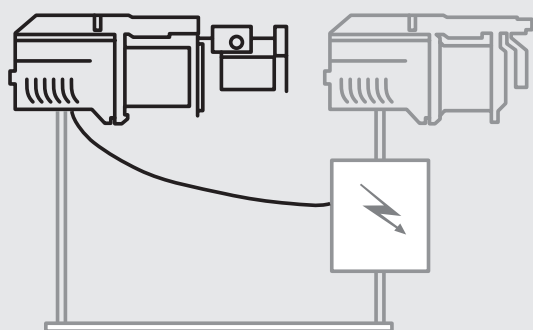

Max unrolling speed	600 m/min
Max bobbin weight:	500 grams
Suitable bobbin external diameter	55, 70, 79 or 82 mm
Suitable bobbin inner diameter	9 mm
Suitable bobbin external length	65, 87 or 96 mm
Connection to X2/X3 Voltage supply box	Maximum two Low Twist X3 units in addition to existing weft accumulators for each box.



BALLOON CONTROL & TENSIONERS



ATC-W Active Tension Control

The required tension is easily set and monitored on the integrated display. Once set, the system constantly regulates itself ensuring consistent yarn tension during the weaving process.

ADVANTAGES

- Yarns of all varying qualities can achieve high productivity with a controlled stable tension
- Yarn tension differences between bobbins is eliminated, resulting in high fabric quality
- Reduced production costs and increased machine efficiency
- Easy and intuitive handling
- Robust, energy-efficient system for stable yarn tension

HOW IT WORKS

The yarn tension is constantly and accurately measured by the ATC sensor unit, sending a signal to the ATC operator unit. Resulting in consistently stable yarn tension at the level required.



RTC Rapid Tension Control

A fast reacting, programmable weft tensioner system. It allows adjusting “within-the-pick” to different tension levels, achieving the optimal tension required for the complete weft insertion cycle.

The user-friendly settings are easy to program using the easily accessible integrated panel. The major advantage with this system is that there is only one setting for the weft tension. With a conventional “brush and brake” set-up, there are two settings that influence the weft tension.

Rapid Tension Control is designed to be an integral part of both Chrono X3/X4 and XD X3/X4 weft-feeders.

ADVANTAGES

- Very fast and precise operation
- Only one setting for weft tension
- Versatile, suitable for most yarn types
- Self-cleaning brake
- Reduced production costs and increased machine efficiency
- Robust, energy-efficient system for optimal yarn tension



ATC Uni-brake

This innovation combines the two best advantages from the world of high-performance brakes. It actively works to always maintain pre-determined yarn tension level.

The Uni-Brake with its unique tensioning design in combination with the active tension control that maintain pre-determined level of tension, unaffected by variable external factors.

ADVANTAGES

- Designed to handle yarns with low twist/non twist in a gentle way
- The user-friendliness of the Uni-Brake follows into this design as well
- Simple setting, same as for ATC-W
- Reproducible settings



TEC Weaving machine controlled active tensioner

The TEC is a proven and reliable programmable tensioner suitable for all modern rapier weaving machines equipped with CAN. Fully controlled and set via the weaving machine panel.

The TEC can also be equipped with optional automatic cleaning.

ADVANTAGES

- Extremely fast and precise operation
- Integrated pneumatic cleaning
- Suitable for most yarn types
- Excellent yarn tension regulation, reaction time 2.5 ms for maximum effect.
- Good knot passage, tilts the leaf (1.4 g) to reduce yarn tension peaks
- Good wear resistance



S-Flex Compensating tensioner and balloon control

Expanding on the design of the M-Flex, the S-Flex has been developed with a design focused on the combination of “balloon control” and “braking”. Functionality that covers a range of typical yarns and applications.

An optimized braking cone ensures a solution with excellent performance and further improved resistance to wear.

Performance, versatility and longevity are the driving factors behind the development of this new family of brakes, where one brake is able to cover an extensive range of applications.

ADVANTAGES

- For low and constant tension, these brakes can replace natural soft brushes, with the great advantage of being self-cleaning.
- Designed to achieve the criteria of a “one brake, one application” solution. See also our application recommendations.
- High resistance to wear.
- Compact modular design
- Compatible with the optional pneumatic threading system
- Available with special soft material in the cone

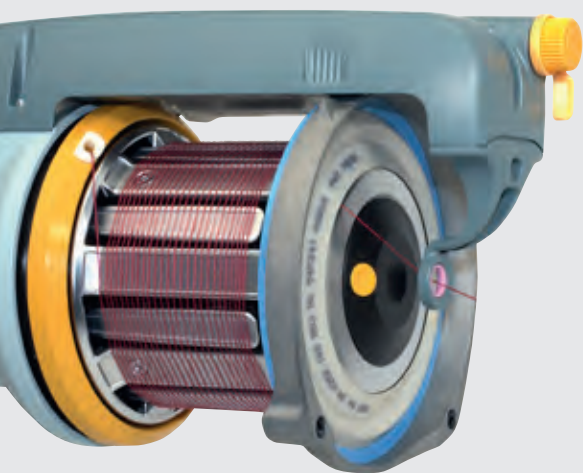

E-Flex Compensating tensioner and balloon control

The most popular combination of tensioner and balloon control on the market today.

The E-Flex has proven to be a very flexible solution for spun yarns and is appreciated by customers worldwide. This patent protected item continues to be a corner stone for solving tension difficulties on an array of different yarns.

ADVANTAGES

- High-wear resistance
- Low dust creation/accumulation
- Self-cleaning tension surfaces



Lamella Tensioner and balloon brake

A combination of tensioner and balloon brake widely used for high-twisted yarns and delicate thin yarn applications.

The yarn is handled gently and ensuring the required tension level.

ADVANTAGES

- High-wear resistance
- Self cleaning tension surfaces
- Especially suited to high twist and silk yarns



CAT Coaxial output tensioner

A compensating tensioner for mid/low speeds, that is suitable for most yarns. Particularly suited to give excellent results with endless filament yarns

Has a high wear resistance. And is a self-cleaning unit. With a ceramic version for extreme wear conditions.

ADVANTAGES

- Compensating tensioner for mid/low speeds
- High-wear resistance
- Self cleaning
- Ceramic version for extreme wear conditions
- Suitable for most yarns



Uni-Brake Leaf tensioner

The Uni-brake surpasses all existing models of traditional leaf tensioners. High performance, extended longevity and user-friendliness are key elements of the Uni-Brake.

There are different models of the Uni-Brake available. Each one is designed to help our customers achieve perfect fabric.

Output	Input
Single with compensator	Single
Single without compensator	-
Double with compensator	-

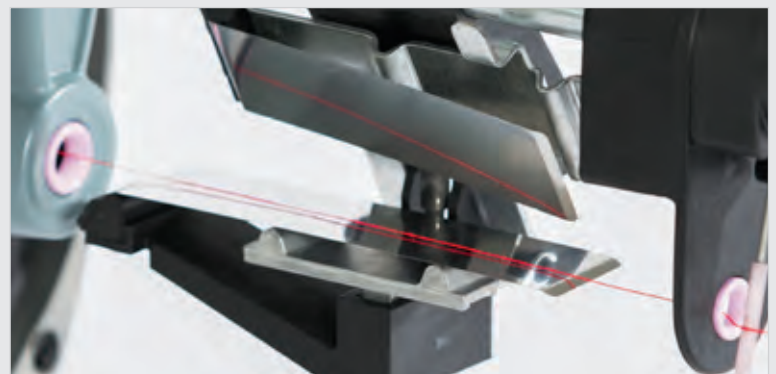

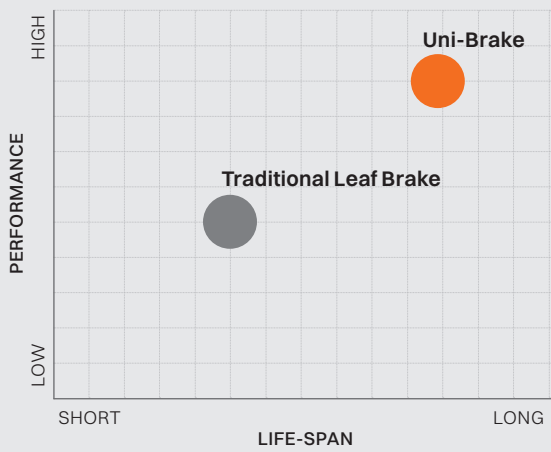

USER FRIENDLY

Simple “lever operation” for thread-up and cleaning, coupled with an improved regular cleaning schedule due to the flexible long tension leaves, makes the Uni-brake extremely user-friendly.

PERFORMANCE

The combination of the long braking surface and the flexible tension leaves of the Uni-brake, means knots and yarn irregularities are handled far more effectively than previously possible. Resulting in reduced yarn stress caused by tension peaks.

LIFE-SPAN

The life-span of the tension leaves used on the new Uni-brake is dramatically improved thanks to the braking surface being 10 times that of a traditional brake.



BALLOON CONTROL



Brush Balloon control only

The traditional brush element used for balloon control when the yarn is inserted into the weaving machine.

Exists in many different versions, including: Direction orientated bristles for the optimum performance, different bristle materials and a range of bristle thicknesses.

Our vast experience has created a range of brushes available today for all weaving requirements.

ADVANTAGES

- Versatile
- Large variety of versions depending on yarn type
- Suitable for most yarn types

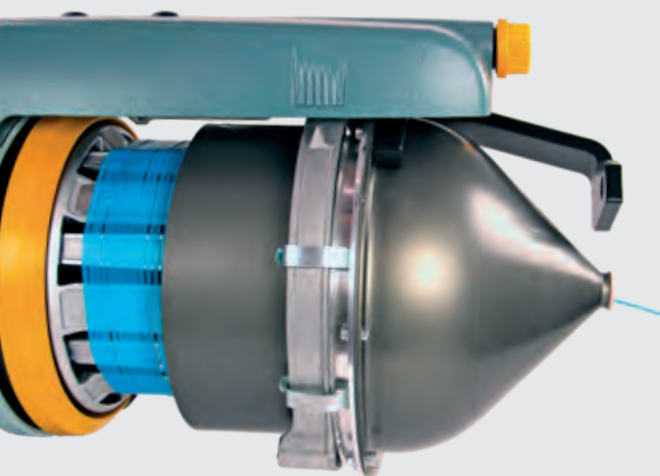

Balloon breaking cone or funnel

This item can be supplied when the combination of the yarn weight and the insertion rate (meter per minute) of the weaving machine requires that the yarn balloon is correctly controlled.

These are for extreme applications and are needed to ensure the yarn can be inserted correctly into the weaving machine.

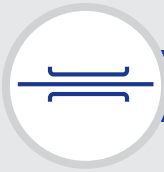

TENSIONERS

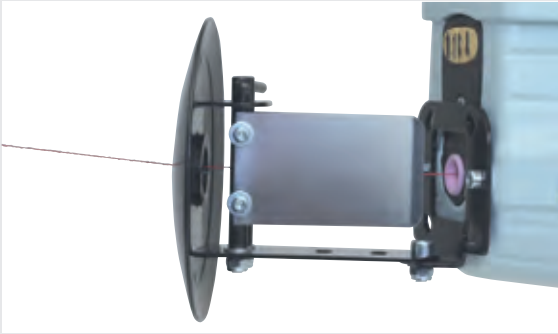

Leaf tensioner Traditional

The traditional Leaf brake system is very versatile for applying tension to a yarn, and covers most yarns used today.

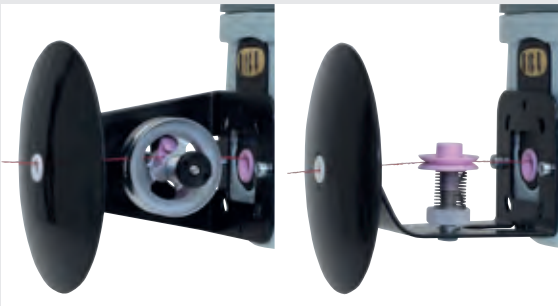

Rotating disc tensioner

Exists in two versions. The metal disc execution is suitable for spun yarns, and the ceramic disc execution is recommended for filament yarns.

This brake type has one major advantage, it is self-cleaning. Mainly used at the input side of a weft feeder.



Double Ceramic disc tensioner

This tension device is used mainly for monofilament yarns where the demand for double braking surfaces in combination with rotating disc with smooth surfaces are of advantage.

The device can easily be made with four individual disc brakes by adding one more plate, thereby achieving four contact points, all to reduce the avivage build up.

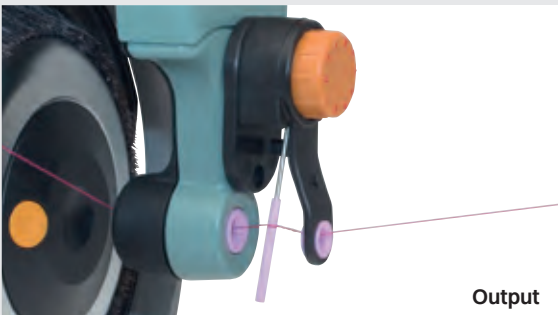

Compensator

A compensator is used when the yarn needs to be stretched before weft-insertion.

A compensator can be used for most yarns, but is mainly used for twist yarns. There are versions for mounting on both the input and output sides of a weft-feeder. Combinations of leaf brake assemblies fitted with compensators are available.

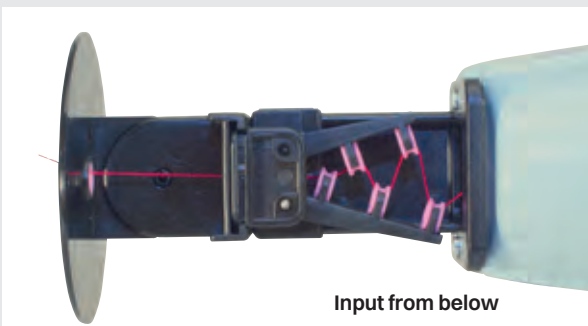

Input from below

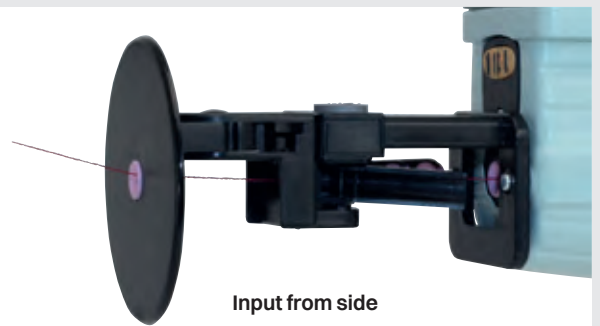

Input from side

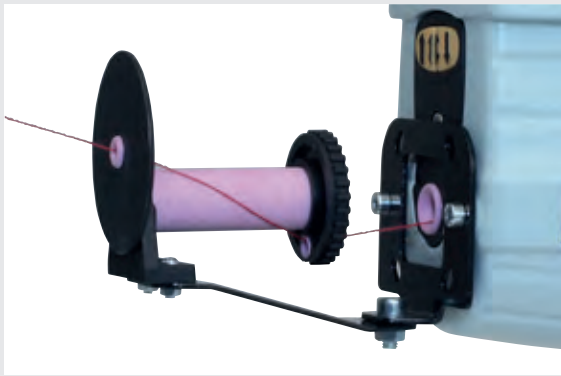

Twine-Around tensioner

The Twine-Around Brake is used for yarns which have a twist greater than 2000 turns/meter (crepe, silk, viscose, etc.), and where snarls may form during yarn movement.



YARN BREAK SENSORS



Piezo sensor

External piezo sensors for multiple yarn insertions. The multi yarn sensor system can control a combination of up to eight wefts divided between up to four weft-feeders at the same time.

The TFE-8 Piezo sensors ensure a high level of sensitivity with a minimum increase in yarn tension. The compact design makes the system extremely simple to install.

This system is available both for rapier and air jet feeders.

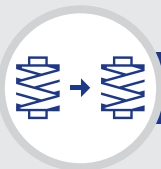

BOBBIN SWITCH SENSORS



Bobbin Switch Sensor (BSS)

Compact Sensor designed for integration in the CAN communication system.

It is designed to give an instantaneous, reliable indication of bobbin switch-over, allowing the weaving machine to take the appropriate measures. The BSS is extremely simple to install.

MULTIPLE USES

- Signal to change the air pressure level on an Airjet machine
- Activate knot removal cycle (between yarn bobbins) for knot free weaving
- Signal that a yarn bobbin needs renewing
- Supply information to a data collecting system

ADVANTAGES WITH OUR SOLUTION

- Simple and efficient function
- One moving part
- Low yarn tension at switch-over
- Robust and compact design

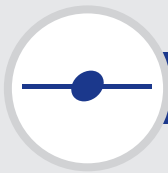

KNOT SENSORS



Knot sensor

The Knot Sensor, for simple and precise monitoring of knots in the weft.

The detector/sensor is integrated with the feeder's CAN communication network giving immediate reaction to irregularities. Can also be used with stand-alone systems.

The virtually contact-free design of the detector ensures that no additional tension is applied to the yarn even when weaving at maximum insertion velocity.

- The unit is easily installed and can be used together with all the input and output components in the system.
- Yarn-count range: Nm 40 - Nm 150
- Easily adjusted to the required yarn count
- No wearing parts
- Power supply and signal directly from the feeder.



LUBRICATORS

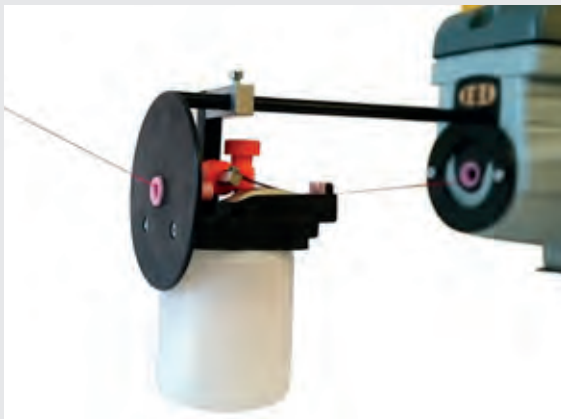

Mechanical weft lubricator

By using a mechanical weft lubricator the traditional dispensing method to apply oil (or other fluids) on to the weft yarn makes it possible to give increased yarn strength and improved performance.

The lubricator is available both as a "feeder-mounted" version, and as a "creel-mounted" version.



Powered weft lubricator

The powered weft lubricator is an automatically controlled oil dispensing device for use on all feeders.

The Oiler is integrated into the systems communications network and is therefore fully synchronized with the feeder's insertion speed.

The dosage rate of the oiler can be electronically adjusted allowing the application of lubricant to be exactly adapted to the required volume. The unit is extremely simple to install and can be used together with all other input and output components in the X3/X4-system.

The feed cylinder is self-cleaning and it is powered by a maintenance free synchronous motor.

The powered lubricator has many production advantages, such as; even weft lubrication, reduced lubricant waste, reduced wet spots, improved fabric quality, reduced weft breakage - enabling increased weaving efficiency and speed.

Input wax paraffin device

A bracket to add in the rear of the weft feeder when paraffin is used as lubricant for the weft yarn.

Simple in the design, but very effective and does the job.

Note: Paraffin not included when delivered.

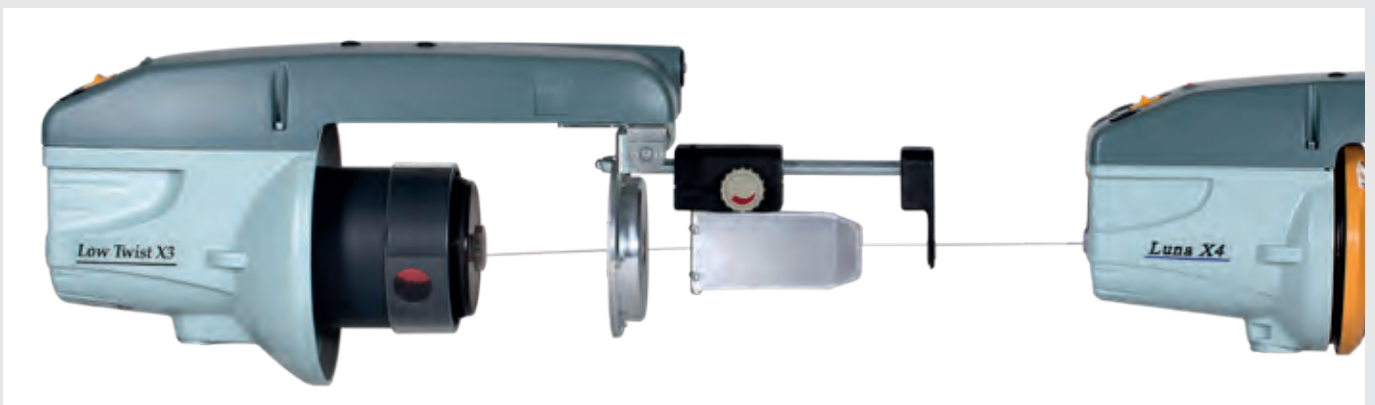
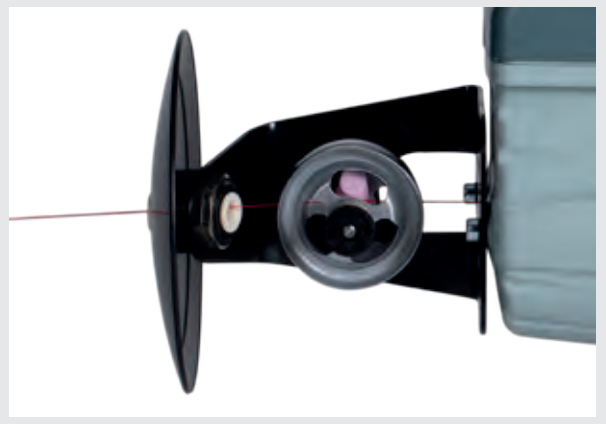
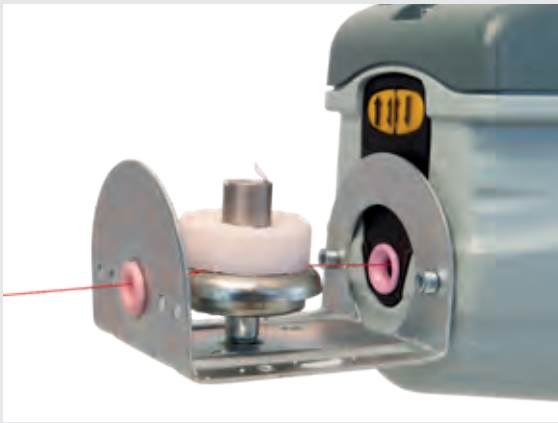

Accessories overview

	Wool (page 16)	Furnishing and upholstery (page 16)	Shirting (page 17)	Denim (page 17)	Silk, filament and fancy fabrics (page 18)	Curtains (page 19)	Bed sheeting and towels (page 20)	Table cloth and household linen (page 20)	Automotive/ Technical fabrics (page 21)
Low Twist X3 (page 23)		•			•				
ATC-W (page 24)	•	•	•	•	•	•	•	•	•
RTC (page 24)	•	•	•	•	•	•	•	•	•
ATC Uni-brake (page 24)	•	•	•	•	•	•	•	•	•
TEC (page 25)	•	•	•	•	•	•	•	•	•
S-Flex (page 25)	•	•	•	•	•	•	•	•	•
E-Flex (page 25)	•	•	•	•	•	•	•	•	•
Lamella (page 26)		•			•	•		•	
CAT (page 26)	•	•	•	•	•	•	•	•	•
Uni-Brake (page 26)	•	•	•	•	•	•	•	•	•
Brush (page 27)	•	•	•	•	•	•	•	•	•
Balloonbreaking cone or funnel (page 27)									
Leaf tensioner (page 28)	•	•	•	•	•	•	•	•	•
Rotating disc tensioner (page 28)	•	•	•	•	•	•	•	•	•
Double Ceramic disc tensioner (page 28)									•
Compensator (page 28)	•	•	•	•	•	•	•	•	•
Twine-Around tensioner (page 29)		•			•	•			
Piezo sensor (page 29)	•	•	•	•	•	•	•	•	•
BSS (page 29)	•	•	•	•	•	•	•	•	•
Knot sensor (page 30)	•	•	•		•	•		•	•
Mechanical oiler (page 30)	•	•			•	•		•	
Powered weft lubricator (page 30)	•	•	•		•	•		•	
Input wax paraffin device (page 31)	•	•	•		•	•		•	

Vandewiele Sweden AB/ROJ Srl reserve the right to change the contents and/or specifications without prior notification. Recommendations are only guidelines. For best performance tests must be carried through.

Perfect accessories for Weft feeders



	Chrono X4 (page 4)	Luna X4 (page 4)	XD X4 (page 6)	HD X3 (page 7)	XD X3 plus (page 8)	Stella G2 (page 10)	Laser G2 (page 10)	Star G2 (page 11)
Low Twist X3 (page 23)	•	•	•	•	•	•	•	•
ATC-W (page 24)	•	•	•					
RTC (page 24)	•		•					
ATC Uni-brake (page 24)	•	•	•					
TEC (page 25)	•	•	•					
S-Flex (page 25)	•	•	•	•	•	•	•	
E-Flex (page 25)	•	•	•	•	•	•	•	
Lamella (page 26)	•		•					
CAT (page 26)	•	•	•			•	•	•
Uni-Brake (page 26)	•	•	•	•	•	•	•	•
Brush (page 27)	•	•	•	•	•	•	•	•
Balloonbreaking cone or funnel (page 27)			•	•				
Leaf tensioner (page 28)	•	•	•	•	•	•	•	•
Rotating disc tensioner (page 28)	•	•	•	•	•	•	•	•
Double Ceramic disc tensioner (page 28)	•	•	•	•	•	•	•	•
Compensator (page 28)	•	•	•	•	•	•	•	•
Twine-Around tensioner (page 29)	•	•	•	•	•	•	•	•
Piezo sensor (page 29)	•	•	•	•	•			
BSS (page 29)	•	•	•	•	•			
Knot sensor (page 30)	•	•	•	•	•			
Mechanical oiler (page 30)	•	•	•	•	•	•	•	•
Powered weft lubricator (page 30)	•	•	•	•	•	•	•	•
Input wax paraffin device (page 31)	•	•	•	•	•	•	•	•

Vandewiele Sweden AB/ROJ Srl reserve the right to change the contents and/or specifications without prior notification. Recommendations are only guidelines. For best performance tests must be carried through.

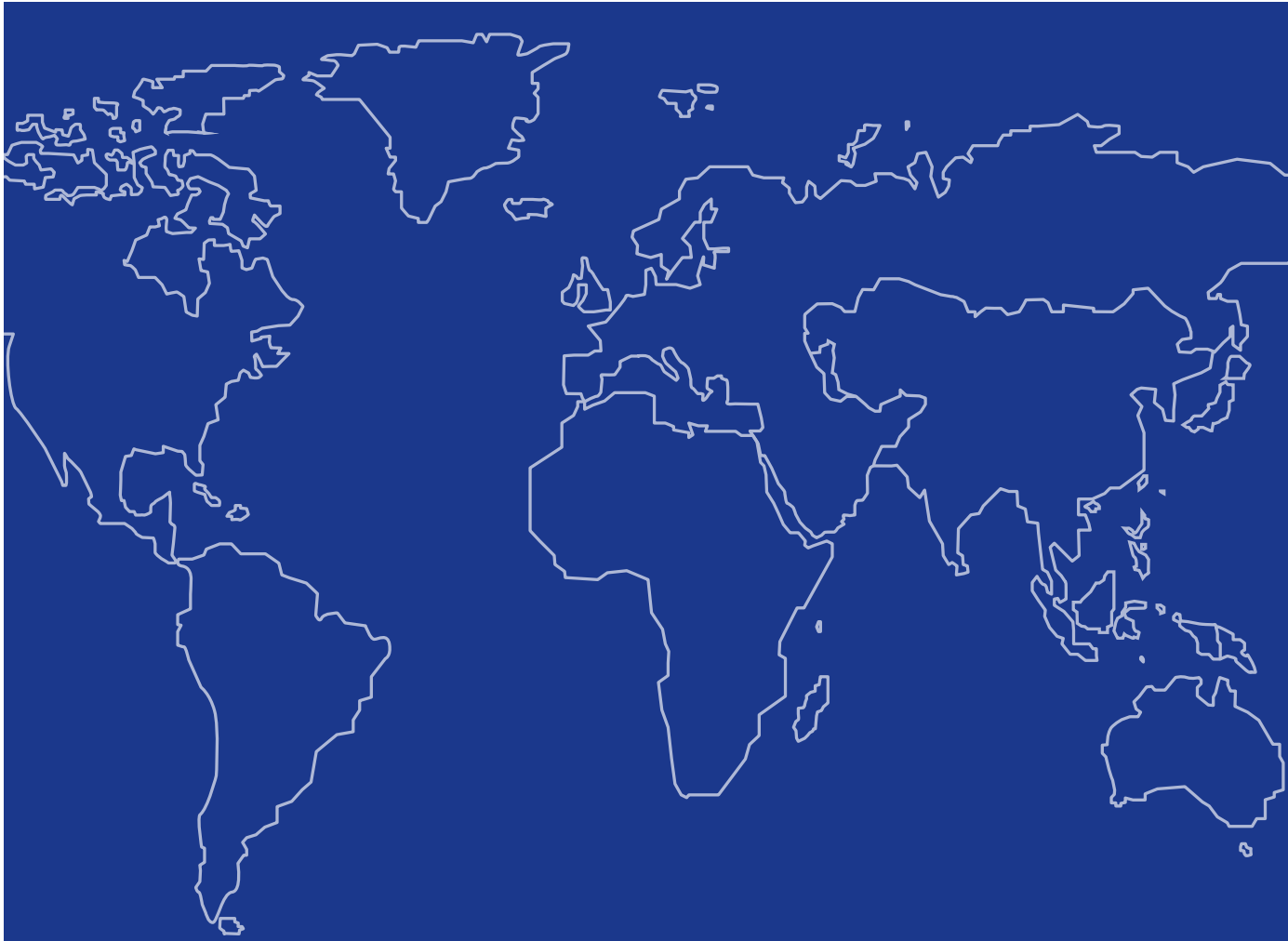

Find your nearest **Sales agent**

Scan the QR code below with your mobile phone
and find your nearest Sales and Service agent
for IRO and ROJ products.



ROJ





Customer-oriented solutions for the factory of the future in textile machines and mechatronics

We imagine, build and integrate innovative textile systems for flooring qualities, home linen, fashion fabrics and technical textiles. Sharing inspiration and expertise with our customers worldwide, we shape the textile industry of the future. Creating success for them all, from yarn to finished product.



Vandewiele Sweden AB
Box 54, SE-523 22 Ulricehamn, Sweden
Phone +46 321 297 00, Fax +46 321 298 00
info@vandewiele.se www.vandewiele.se

ROJ
A VANDEWIELE COMPANY

ROJ Srl
Via Vercellone 11, IT-13900 Biella, Italy
Phone +39 015 84 80 111, Fax +39 015 40 58 15
comm@roj.com www.roj.com